

Prenatal Sci. Global Congress, Prenatal Sciences Partnership, 6-9.10.2022 (Online);  
All about People: Relevance of Sci. & Edu, Alma Mater Eur. ECM Maribor, 13-14.03.2020 (Postpon);  
13. HUPED kongres: Znanstveni dokazi u nekonvencionalnoj medicini, Zagreb, 6-7.12.2019.

# ON HOLISTIC PSYCHOSOMATIC NATURE OF BIOENERGYCORRECTION

**Dejan Raković\***

\*Prof. in retirement, Faculty of Electrical Engineering, Belgrade, Serbia

[rakovicd@etf.bg.ac.rs](mailto:rakovicd@etf.bg.ac.rs)

[www.dejanrakovicfund.org](http://www.dejanrakovicfund.org)

*I live that humanity could still live.*

**Bruno Groening**

**Bioenergycorrection** as an ancient way of correction of flow of **vital energy** is known in many traditions for millennia, enduring test of time to present day, with some modern modifications [1]. On the expansion of **integrative medicine** since mid-1990s in China, US & Europe, some *bioenergy-correction techniques* were subjected to *scientific research* & included in local medical *curricula*.

Our biophysical studies of consciousness & psychosomatics also point to **real nature of holistic experiences** of traditions of East & West [2,3], implying that quantum-holographic / fractal hierarchical parts carry information on wholeness (like Hindu relationship *Braman / Atman*), enabling **subtle quantum-holographic coupling of hierarchical levels in Nature**. This is indicated by *acupuncture system & its projection zones* (ECIWO holographic concept), *discovery of quantum-holographic influence on genome expression* (speech-modulation of illuminating-laser-signal), *transpersonal origin of incredible creativities* (Tesla & Mozart as case studies), and *predestined life paths & temptations* (suggested by experiences from hypno-regressions & tribal traditions & traditions of East & West, *emphasizing* that they can nevertheless be *optimized by spiritual purification*).

These traditional concepts are also supported by **holographic principle** that each (3D) physical system is *isomorphic* to holographic information imprinted on its (2D) surface, implying that quantum content of 3D body *could be holographically contained* in body's 2D surface layer – *in line with our quantum-holographic / quantum-gravity (QHQG) theoretical framework of consciousness & psychosomatics* & supposed *close relationship of acupuncture system & consciousness* (which is supported by *meridian (psycho / energy) therapies*).

*Biophysical research of **integrative medicine & transpersonal psychology** is of special importance due to widespread usage in developed countries – as contemporary investigations of stress-induced psychosomatic diseases suggest necessity of **holistic methods** (focusing on the **acupuncture system & consciousness**), oriented to treating man as a whole, suggesting their **macroscopic quantum origin** – with significant global implications [2,3]. So it may be said that there are **three front lines of psychosomatic (quantum-holographic) integrative medicine**: **(i) spirituality & circular (psycho / energy) therapies from all relevant meta-positions** (with permanent removal of mutual quantum memory attractors (states) on the level of collective consciousness, due to energy-informational dis-entanglement of mental addresses of all persons involved in the problem); **(ii) (quantum) holistic medicine & non-circular (psycho / energy) therapies** (which temporarily remove memory attractors on the level of the acupuncture system / individual consciousness & prevent or alleviate their somatization, as a result of negligence on the first front line); and **(iii) symptomatic conventional medicine** (which via immunology, pharmacology, biomedical diagnostics and surgery on somatic level prevents or alleviates consequences of carelessness on the first two front lines).*

It should be particularly noted that the *necessary activities* in the second and third front lines, with *neglect of the first one*, would result in **further transfer of memory attractors** on the level of individual & collective consciousness in this and future generations, thus **accumulating quantum-holographic nonlocal loads** that cause then not only diseases but also interpersonal conflicts, wars and other sufferings.

Further on, **three aspects of the acupuncture system, consciousness & vital energy** should be pointed out [2-3]: **(i) quasi-classical ionic aspect of the acupuncture system** (suggested by research of the non-threshold "gap junction" electrical synapses, which have shown an order of magnitude increased concentration at the acupuncture points, that is consistent with a much lower electrical resistance of the acupuncture points compared to the surrounding tissue, as well as a significantly higher absorption of the airoions in these points); **(ii) quantum-informational electromagnetic aspect of the acupuncture system** (indicated by *quantum-coherent characteristics* of Russian-Ukrainian school of *microwave resonance therapy*, and discovery that any quantum system has formal mathematical structure of *Hopfield quantum-holographic associative neural network*; it is also pointed out that *acupuncture system is at least psychosomatically related to consciousness*, as supported by very effective *meridian (psycho / energy) therapies* with successive setting new boundary conditions in *the acupuncture system during emotionally-involved visualizations of psychosomatic problem*); and **(iii) transpersonal exotic aspect of energy-informational communications** (known in all traditions, and now widely used in transpersonal energy therapies (such as Qigong, Reiki, Pranic healing...) – through *established and stabilized energy-informational channels of vital energy (qi, ki, prana...)* – pointing to a deeper exotic space-time nature of these channels of vital energy (i.e. connection with exotic quantum vacuum fluctuations, necessary for anti-gravitational stabilization of these space-time channels)).

So, it seems that **joint research** on the crossroad of **psychosomatic integrative medicine & quantum informatics** may become **fruitful** in spreading frontiers of the existing scientific paradigm.

But Will the South Be So Kind?

BDD

WANTAM DOUBLEDAY DELL AUDIO PUBLISHING

# U.S. News & WORLD REPORT

JANUARY 21, 2008

## Alternative Medicine Goes Mainstream

Top hospitals are now embracing such unconventional techniques as acupuncture, homeopathy, and energy healing.

**Do they really work?**  
**What patients need to know**

\$4.99 U.S. / \$5.99 CANADA



www.usnews.com

# QUANTUM HEALING

## EXPLORING THE FRONTIERS OF MIND/BODY MEDICINE



### DEEPAK CHOPRA, M.D.

# TRANSPERSONAL PSYCHOLOGIES

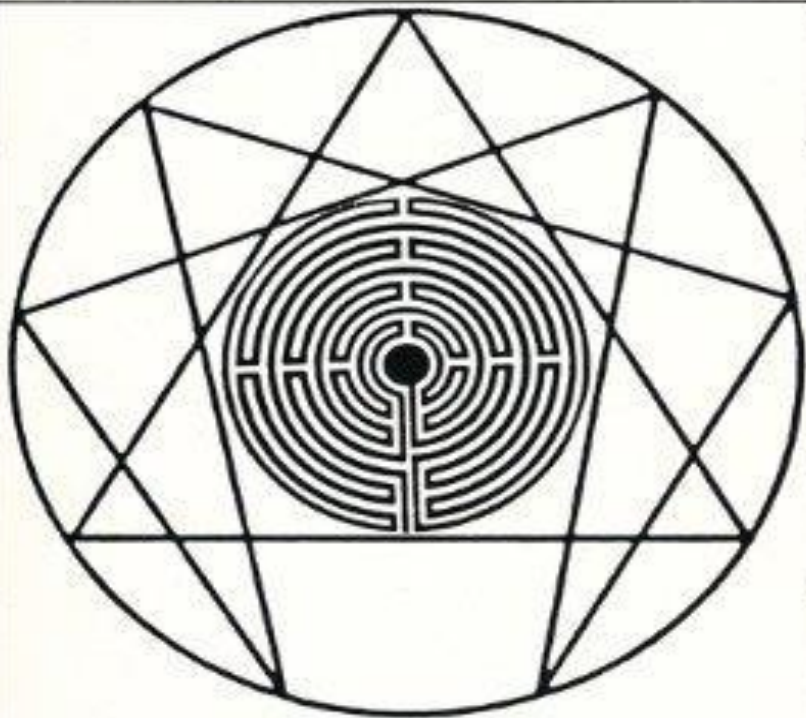

**EDITED BY CHARLES T. TART**

PSYCHOLOGICAL PROCESSES, INCORPORATED \$ 12.95

Using Your Thoughts to Change  
Your Life and the World

# The Intention Experiment

Lynne McTaggart

Author of *THE FIELD*

Take Part  
in the  
World's Largest  
Mind-Over-Matter  
Experiment



**CENTER FOR  
CONSCIOUSNESS  
STUDIES**

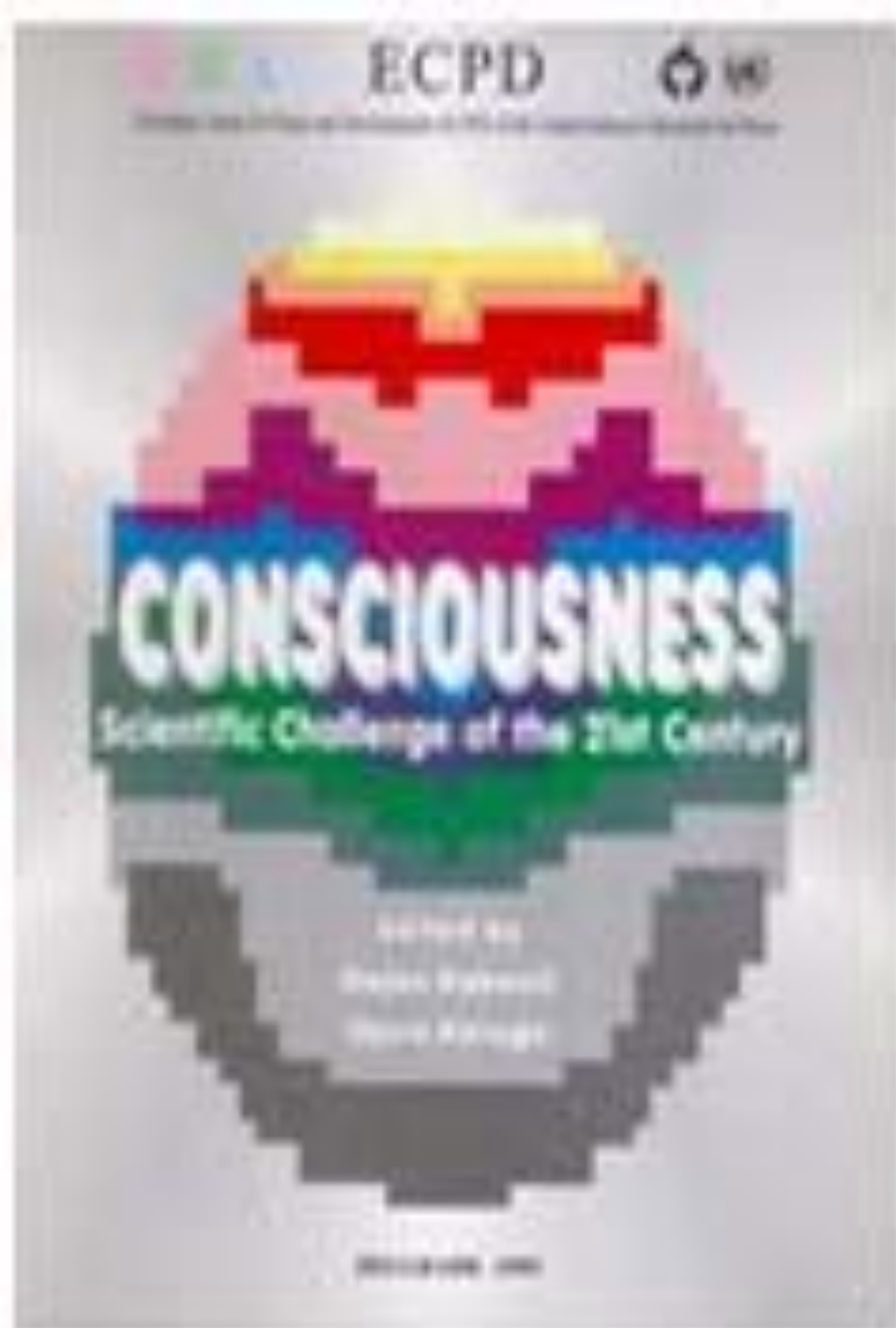



# 2010: 46 Members

Albert Einstein/Yeshiva University  
Boston University  
Columbia University  
Duke University  
Georgetown University  
George Washington University  
Harvard Medical School  
Johns Hopkins University  
Laval University, Quebec  
Mayo Clinic  
McMaster University,  
Ontario  
Northwestern University  
Ohio State University  
Oregon Health &  
Science University  
Stanford University  
Thomas Jefferson University  
University of Alberta  
University of Arizona  
University of Calgary

University of California, Irvine  
University of California, Los Angeles  
University of California, San Diego  
University of California, San Francisco  
University of Chicago

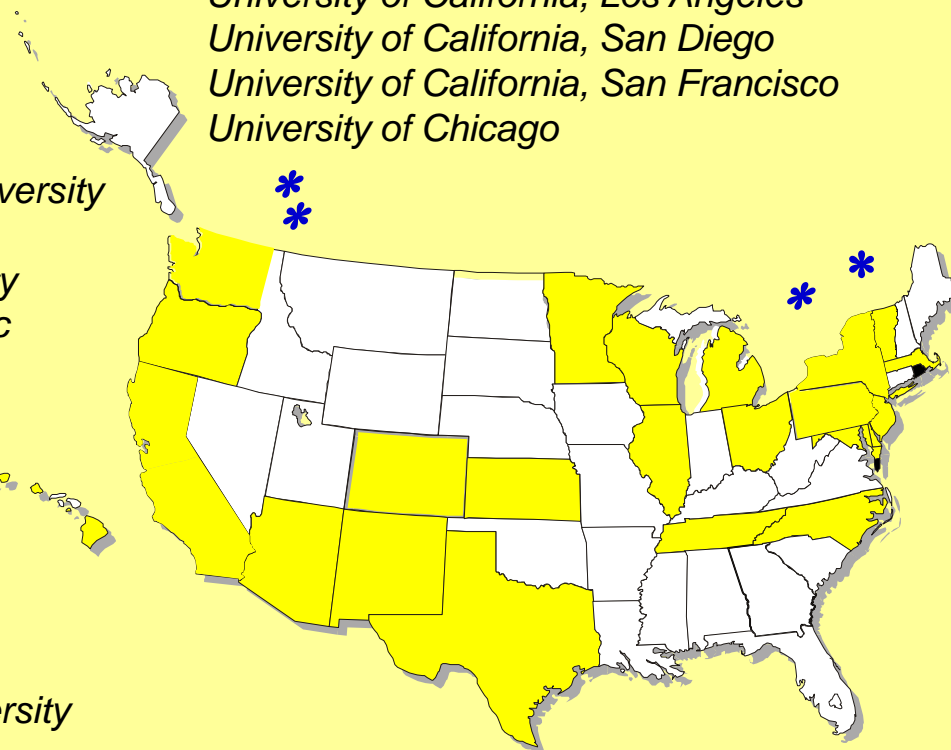

University of Colorado  
University of Connecticut  
University of Hawaii  
University of Illinois

University of Kansas  
University of Maryland  
University of Massachusetts  
University of Medicine &  
Dentistry of New Jersey  
University of Michigan  
University of Minnesota  
University of New Mexico  
University of North  
Carolina, Chapel Hill  
University of Cincinnati  
University of Pennsylvania  
University of Pittsburgh  
University of Texas  
University of Vermont  
University of Washington  
University of Wisconsin  
Vanderbilt University  
Wake Forest University  
Yale University





# THE HOLOGRAPHIC UNIVERSE

MICHAEL TALBOT

A Remarkable New Theory of Reality that Explains:

- the Latest Frontiers of Physics
- the Paranormal Abilities of the Mind
- and the Unsolved Riddles of Brain and Body

*New Edition*

# THE ATMAN PROJECT

A Transpersonal View of  
Human Development

Ken Wilber

*By the author of Sex, Ecology, Spirituality; The Spirit of Evolution*

LEONARD SUSSKIND • JAMES LINDESAY

AN INTRODUCTION TO  
**BLACK HOLES, INFORMATION** and the  
**STRING THEORY REVOLUTION**

The Holographic Universe

RETHINKING THE LESSER BRAIN • THE VAPORS OF PROPHECY

# SCIENTIFIC AMERICAN

Why the  
Digital Divide  
Does Not  
Compute

March 2001  
\$4.95

## ARE YOU A HOLOGRAM?

(Quantum physics says the entire universe might be)

Censoring  
Bad Genes

The True  
Planet of the Apes



Author is dealing with the research and educational work in the fields of integrative biophysics, quantum medicine and quantum-holographic informatics for many years, and as a connoisseur of classical and quantum physics explains biophysical phenomena and provide arguments for the application of integrative biophysical diagnostic and therapeutic methods and techniques in medicine.

Bearing in mind that contemporary research indicates the increasing presence of psychosomatic factors in the origin of many diseases, then the inclusion of psychological phenomena (consciousness, stress, etc.) oriented to the treatment of man as a whole and not of diseases as symptoms, represents a shift in the diagnosis and treatment of human health, in respect to the classical medicine. The book also makes a shift in the field of traditional medicine, as it provides a satisfactory explanation for the application of some traditional methods and techniques...

The monograph is of the multidisciplinary character and is primarily dedicated to open-minded physicians who practice classical and traditional medicine, to specialists and students of the postgraduate studies in biophysics and biomedical engineering, as well as to all those interested in the application of new scientific methods and techniques in medicine...

– Djuro Koruga

According to the structure and contents, the book can be equally classified into a higher educational textbook, but also into a very advanced and specific (by issue and research approach) multidisciplinary (physics, biology, medicine, philosophy) scientific monograph.

The book offers a broader and deeper information about hot development of the biophysics of consciousness at the end of the 20th century and the beginning of the 21st century, which is not only of fundamental importance, but allows a wide implementation, from the genetic to biomedical engineering. In order to understand physics of living nature the whole tool of modern theoretical physics is used, in all levels: from molecular, via cellular and over-cellular, to bodily level, including the biosphere as a whole. Therefore, to help readers the appendices on quantum mechanics, quantum chemistry, and quantum informatics are added.

Generally speaking, before the readers is a unique book-monograph...

– Jovan Šetrajčić



9 788681 187924 51

Dejan Raković

INTEGRATIVE BIOPHYSICS, QUANTUM MEDICINE AND QUANTUM-HOLOGRAPHIC INFORMATICS:  
PSYCHOSOMATIC-COGNITIVE IMPLICATIONS

Dejan Raković

# INTEGRATIVE BIOPHYSICS, QUANTUM MEDICINE AND QUANTUM-HOLOGRAPHIC INFORMATICS: PSYCHOSOMATIC-COGNITIVE IMPLICATIONS

IASC & IEFPG  
Belgrade 2009

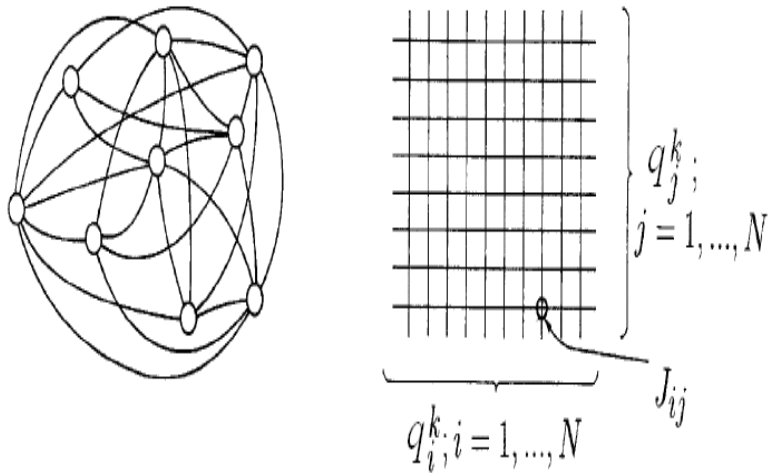
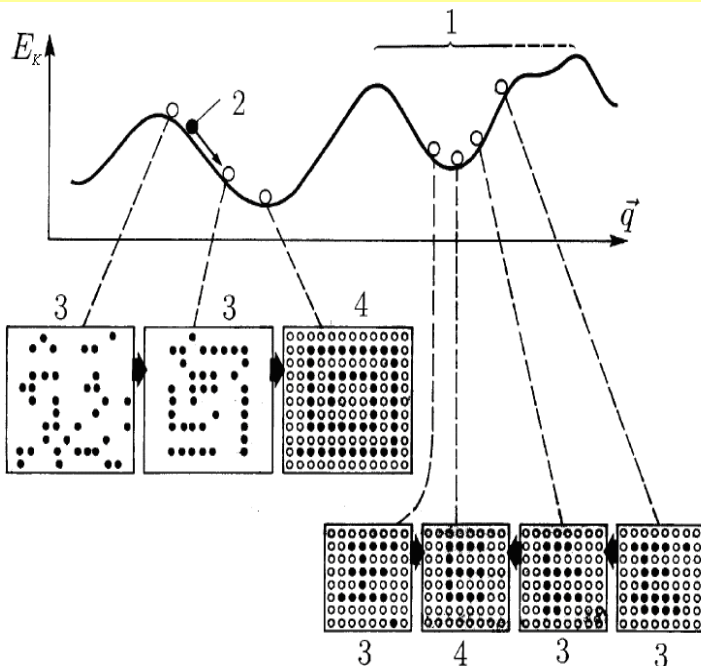

**Figure 1(a).** Diagram of Hopfield's neural network (top left) & corresponding memory matrix  $\mathbf{J}$  (top right).

$$J_{ij} = \sum_{l=1}^P q_i^{k_l} q_j^{k_l}$$

$$q_i = \sum_{j=1}^N J_{ij} q_j$$

$$E_K = -\frac{1}{2} \sum_{i=1}^N \sum_{j=1}^N J_{ij} q_i q_j$$

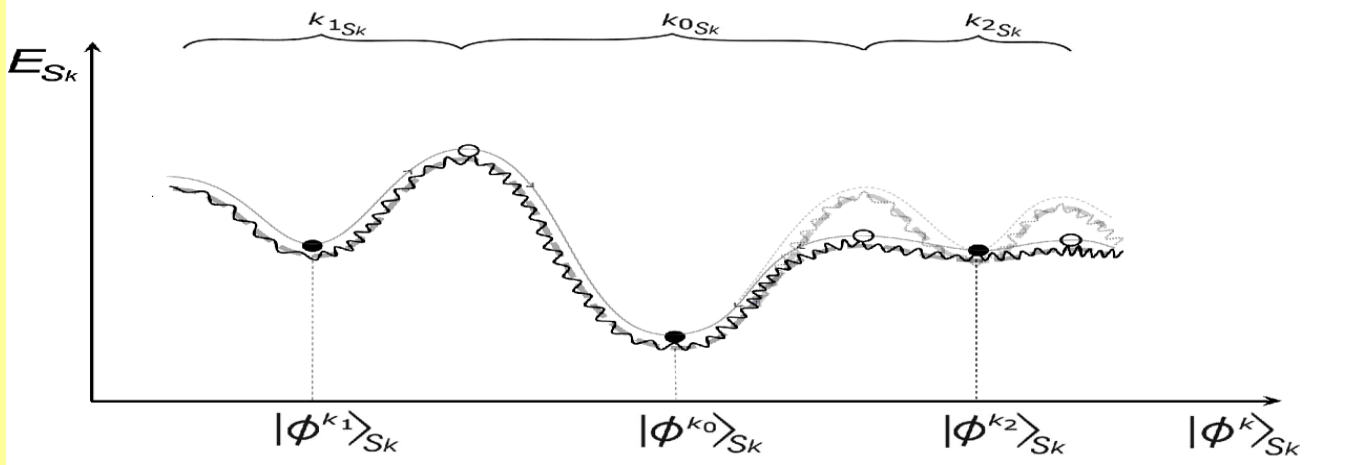

**Figure 1(b).** Energy-configuration hypersurface of Hopfield's neural network (below left):

- 1 - Basin of attraction;
- 2 - Momentary state of the network;
- 3 - Nonstable configuration;
- 4 - Attractor pattern, tj. stable configuration.

### Peruš's Classical vs. Quantum analogies:

$$q \Leftrightarrow \phi, \quad q^{k_l} \Leftrightarrow \phi^{k_l}, \quad J \Leftrightarrow G$$

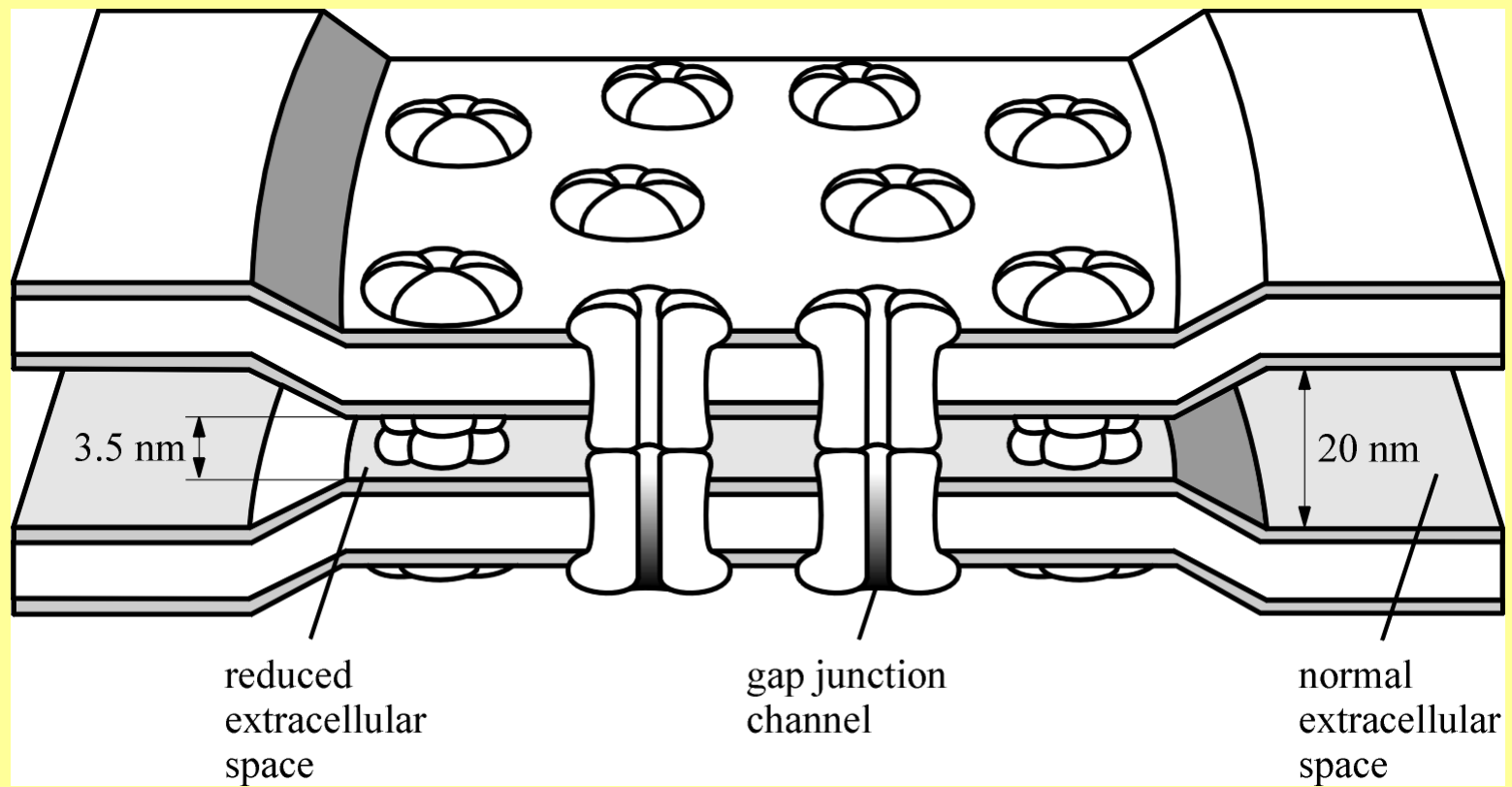

**Figure 2.** Schematic presentation of the adaptation of memory attractors in the energy-state ( $E_{S_k}(\phi^k)$ ) hypersurface of the *quantum-holographic memory* of various hierarchical levels of biological *macroscopic open quantum systems*  $S_k$  (*local cell's biomolecular protein-target, local acupuncture system-consciousness, or nonlocal out-of-body consciousness-collective consciousness*):

$$G(r_2, t_2; r_1, t_1) = \sum_{i=1}^P \phi^{k_i}(r_2, t_2) \phi^{k_i*}(r_1, t_1) = \sum_{i=1}^P A_{k_i}(r_2, t_2) A_{k_i}^*(r_1, t_1) e^{\frac{i}{\hbar}(\alpha_{k_i}(r_2, t_2) - \alpha_{k_i}(r_1, t_1))}$$

It should be pointed out that Nature presumably has chosen elegant *biological room-temperature solution for quantum-holographic information processing*, permanently fluctuating between quantum-coherent  $|\phi^k(t)\rangle_{S_k} =$

$\sum_i c_{k_i}(t) |\phi^{k_i}\rangle_{S_k}$  and classically-reduced  $\hat{\rho}_{S_k}^k(t) = \sum_i |c_{k_i}(t)|^2 |\phi^{k_i}\rangle_{S_k S_k} \langle \phi^{k_i}|$  states of the biological macroscopic open quantum system  $S_k$ , via non-stationary bioresonance interactions with out-of-body farther environment and through decoherence by bodily closer environment. Thus *quantum neural holography* combined with *quantum decoherence* might be very significant element of the *feedback bioinformatics*, from the level of cell – to the level of organism – and further to the level of collective consciousness, with *backward dynamic influence on the expression of genes*. This implies *necessity* of quantum-informational successive *bioresonant balancing* of all unwilling side memory attractors (like  $\phi^{k_2}$  in the Figure), which would cause development of *psychosomatic diseases* on the individual level, and *interpersonal fights* in this and further generations on the collective level.



**Figure 3.** A three-dimensional model of the gap junction channel based on X-ray diffraction studies. Each apposite cell contributes half of a channel (hemi-channel) called a connexon. Each connexon (~ 1.5 nm in diameter) is formed from six hexagonally arranged protein subunits (~ 7.5 nm in length) called connexins, which have the function of self-organization in connexon and linking with the opposing connexon of neighboring cell. The whole process is very flexible and depends on the current state of the cellular environment, with modulating conductivity of GJ-channels by intracellular pH-factor,  $\text{Ca}^{2+}$ -ions, neurotransmitters and second messengers, and even voltage – that are changing the conformational state of connexon (similar to the aperture of the camera).

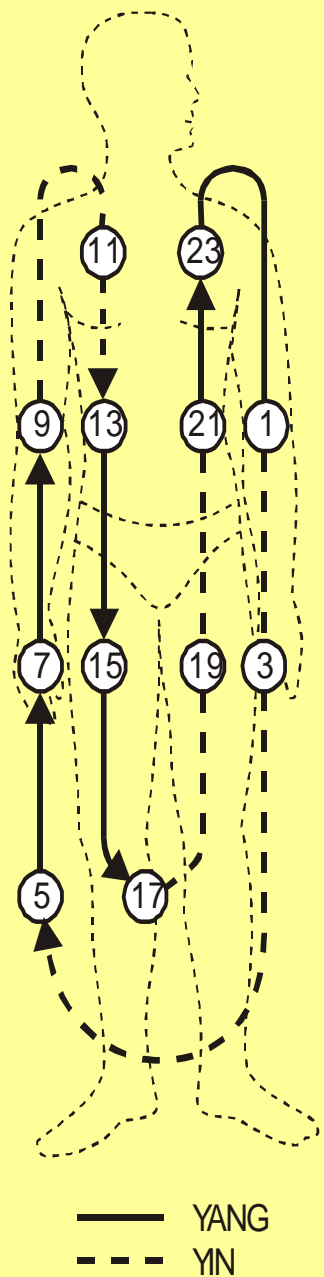

(a)

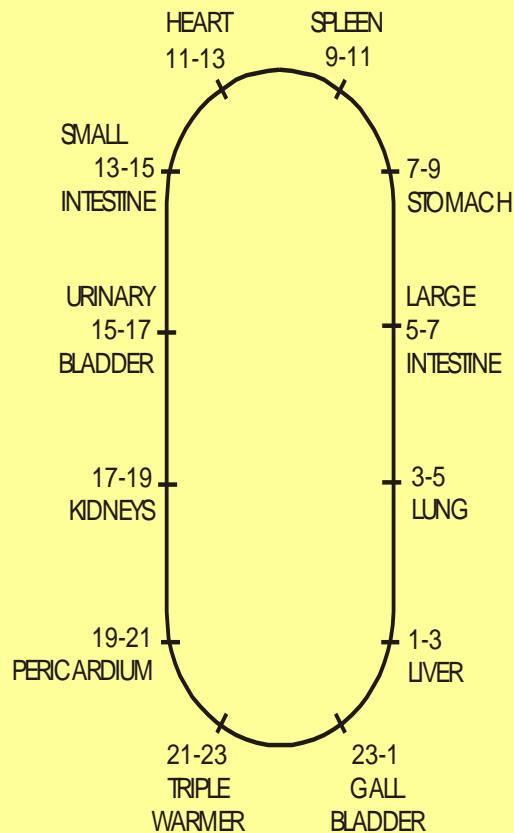

(b)

**Figure 4.** Display of traditional Chinese representation of circulation of qi within human body: (a) during 24 hours, and (b) hours of maximum activity of organs; actually, each side of the body has its almost independent circulation of qi.

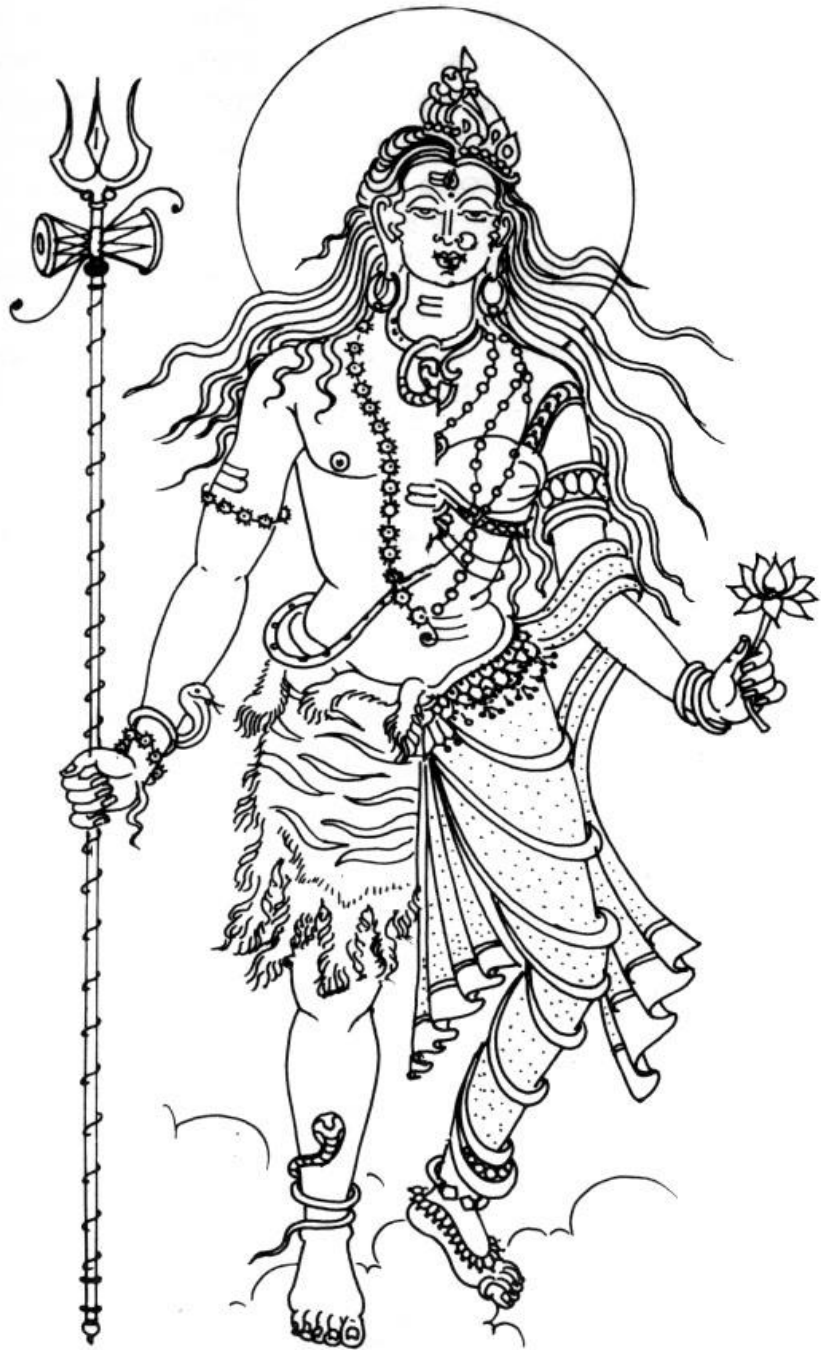
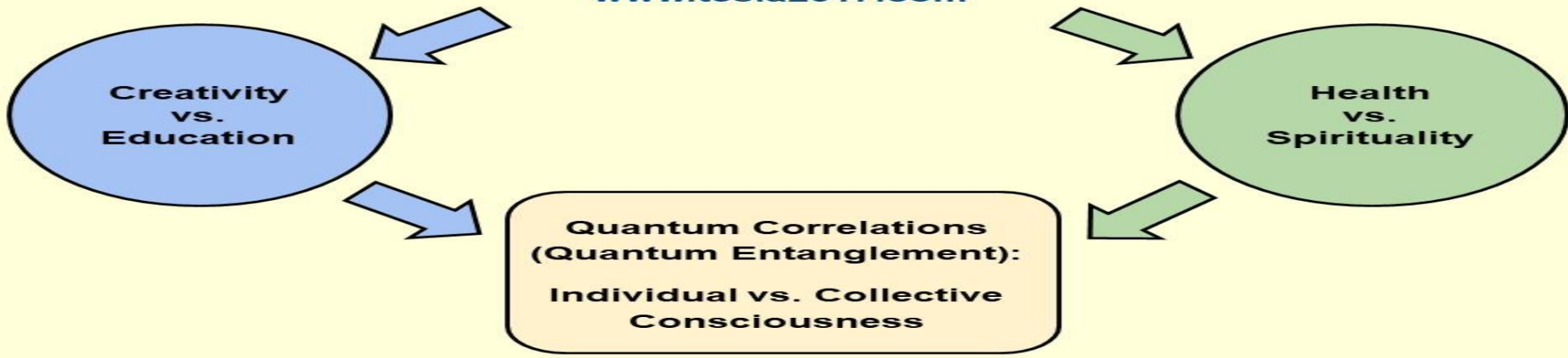

**Figure 5.** Ancient Indian concept of the left-hand side of the body as a female (Shakti) and the right-hand side of the body as a male (Shiva), through the representation of the Hinduistic deity Arda Narishvara.



# Tesla's Inspired Holistic Ideas

[www.tesla2017.com](http://www.tesla2017.com)



$$|\Phi\rangle_S |\Psi\rangle_E \rightarrow \sum_i c_i |\Phi_i\rangle_S |\Psi_i\rangle_E \xrightarrow{p_j = |c_j|^2 \approx 1} |\Phi_j\rangle_S |\Psi_j\rangle_E$$

Figure 6(a). Symbolic representation of **mentally controlled-directed increasing of macro-quantum correlations of interacting individual consciousness (S) & collective consciousness / environment (E) in *transpersonally-entangling creative phases*** (left-hand side of image & formula above, with previous mental increase of focused weight contribution  $c_j$  & subsequent (practically non-stochastic) classically-reduced selection of this dominant weight contribution  $c_j$ ); **(b)** Symbolic representation of **mentally controlled-systemic decreasing of macro-quantum correlations of interacting individual consciousness (S) & collective consciousness / environment (E) in *transpersonally-disentangling spiritual phases*** (right-hand side of image & formula above), with previously systemic mental decreasing of almost all weight contributions  $c_i$  & subsequent (practically non-stochastic) classically-reduced selection of remaining weight contribution  $c_j$  (related to mentally-embedded address on founder of corresponding mystical tradition).

It should be noted that **transpersonally-extended esoteric concepts** of spiritual traditions of East & West could be biophysically accounted within our plausibly **extended QHQG theoretical framework** [2,3]:

**(i) astral body** (*manomaya, linga-sarira, manovijnana, ka, psyche, nephesh, nafs, subtle body, psychic body, soul...*) **vs. ionic component of EM-ionic-exotic macro-quantum acupuncture system displaceable out-of-body** (*connected with body by miniature 'wormhole' space-time tunnel, generated in highly-non-inertial transitional states of consciousness, as reported in extra-sensory near-death experiences*);

**(ii) mental body** (*vijnanamaya, sukksmasarira, manas, ba, thymos, ruach, ruh, noetic body, spiritual body, mind...*) **vs. EM component of EM-ionic-exotic macro-quantum acupuncture system displaceable out-of-body** (*embedded within ionic component of acupuncture system*);

**(iii) distributed centers of consciousness** (*chakras, acupuncture points, sephiroths, holy discs...*) **vs. EM-ionic condensates of EM-ionic-exotic macro-quantum acupuncture system displaceable out-of-body**;

**(iv) vital energy** (*chi / qi / ki, prana / akasha, mana, ka, pneuma / ether / natura medica / anima mundi, yesod, baraka, Uncreated light / Holy Spirit, Heilstrom, Innate Intelligence, bioenergy / biofield...*) **vs. EM-ionic-exotic condensates detectable within EM-ionic-exotic macro-quantum acupuncture channels displaceable out-of-body & non-detectable outside them** (*with possible generalization from EM field to unified field, in line with broader traditional meaning of vital energy, as all-pervasive cosmic quintessence*).

It should be noted that **transpersonal phenomena** are practically incorporated in **psychosomatic energy correction** & that their *physical explanation should be sought at very border of existing scientific paradigm.*<sup>1,2,3,4</sup> Within our QHQG framework of consciousness & psychosomatics, it is assumed they are of deeper **quantum-gravitational origin** (according to Einstein's **Principle of equivalence** of inertial & gravitational accelerations) *in transitional states of consciousness* (from high-dielectric body to low-dielectric out-of-body states!), based on locally generated **wormhole tunnels, quantum-gravitationally stabilized by exotic matter** (*quantum vacuum fluctuations in strongly curved space-time of wormhole tunnels*) with anti-gravitational effects – really observed in transpersonal psychokinetic manifestations of vital energy), with exotic aspect of spatio-temporal tunnels & vital energy extended to acupuncture channels (of exotic vacuum-like refractive index!) **with transpersonal quantum-entangling inflow of vital energy** [2-7].

**[Note 1.** Our QHQG theoretical framework also suggests physical basis for **ad hoc von Neumann projection postulate** (on a micro-quantum scale), to explain **deeper nature of quantum-mechanical collapse of wave function** (via local quantum-gravity-induced 'wormhole' tunnels in equivalent-strong-gravity (according to Einstein's *Principle of equivalence!*) high-non-inertial-quantum-like situations [3,4])! Asked how it is possible that such *highly non-inertial microparticle processes with inevitable opening of miniature 'wormhole' tunnels* were not considered within quantum mechanics, which is nevertheless extremely accurate theory(?) – they appear to be(!) *implicitly within von Neumann's projection postulate* (at deeper quantum-gravity level!).].

[Note 2. Let us also add that **Tesla's visions & inventions**, realized in his controlled altered states of consciousness, have been suggested as manifestations of his meditative insights through **macro-quantum correlations of individual & collective consciousness**, with significant creative-educational & psychosomatic-spiritual implications [3,6].

On the one hand, they can provide guidance for a deeper understanding of our **QHQG theoretical framework for holistic control of creativity & education** – based on **mentally focused transpersonal increasing of macro-quantum correlations of individual & collective consciousness** (as described in Patanjali Yoga Sutras as Ritam Bhara Pragma, 'when mind perceives things as they are'), cf. **Fig. 6(a)**.

On the other hand, they can provide guidance for deeper understanding of our **QHQG theoretical framework for holistic control of psychosomatic & spirituality** – based on **mentally controlled systemic transpersonal decreasing of macro-quantum correlations of individual & collective consciousness** (when only mentally embedded address on founder of corresponding mystical traditions remains at the end of process of dis-attachment), cf. **Fig. 6(b)**.

In broader context, Tesla's overall research can be inspiration for rethinking educational / informational / political goals – with reorientation towards **holistic gentle actions** for global solutions to world risk society.

So, **science is closing the circle**, by re-discovering two modes of knowledge & its own epistemological limitations – as preserved for millennia in **shamanistic tribal traditions** (who consider that true reality is represented by lucid dreams & that waking state is illusion), or as concisely described by **Patanjali in Yoga Sutras** more than two millennia ago (pointing out that mystical experience (samadhi) is 'filled with truth' & 'above inference & scriptures'), or as formulated at beginning of last century by **Berdyayev in Philosophy of Freedom** (as difference of two modes of knowledge, prayer-mediated 'comprehension of affairs invisible' & rationally-mediated 'comprehension of affairs visible')!

Then, aforementioned **consensuses on transpersonal esoteric concepts** in different spiritual traditions, demonstrates that acquired information in their transpersonal experiences may give rise to **non-distorting extrasensory perception** of their mentally-addressed out-of-body environments of collective consciousness (**in Tesla-like creative way, cf. Fig. 6(a)**) – **in contrast to mystical states** (of **distorting collapse of implicate order** of quantum-entangled states of individual & collective consciousness **into particular explicate order** of classically-reduced states of individual & collective consciousness (**specific to corresponding mystical tradition, cf. Fig. 6(b)**)), probably related to **controversy about post mortem evolution of soul**.

Still, **efforts of mystics of all traditions to purify consciousness / soul via spiritual practices** & thus to reach their final **eschatological goal** (Kingdom of God, nirvana...), i.e. **post-mortem** salvation of soul (non-bounded sin-free / karmic-free) by **re-union** (re-ligare / yoga) with God – **might appear reasonable!**]

## TESLA'S LEGACY FOR NEW MILLENNIUM: PATH TO QUANTUM-HOLOGRAPHIC PRIMAL SOURCE

D. Raković

**Abstract.** Nikola Tesla is undoubtedly the greatest inventor in the history of electrical engineering, and what makes him especially fascinating was his unusual mental control of creative visions. Regarding presented Tesla's extraordinary creative experiences in his altered states of consciousness (categorized in his time as nonphysical phenomena) – Tesla's conviction "when we start to study nonphysical phenomena, we will progress more in ten years than we have for centuries" then becomes clearer. In this context, it seems that Tesla's legacy for the new millennium is introspective evidence of his transpersonal creative communications, with fascinating possibility of his meditative eidetic control & increase of macroscopic quantum correlations with the quantum-holographic primal source of collective consciousness. In this lecture it will be pointed out that they could serve as an extraordinary case study for understanding biophysical basis of both transpersonal psychology & control of creative processes, based on subtle interplay of normal & transitional & altered states of consciousness in meditation & sleep, which may help in developing future strategies for education. These insights could also provide deeper understanding of Hopfield-like neural-networks quantum-holographic framework for quantum-informational transpersonal psychosomatics, based on decrease of quantum entropy & macroscopic quantum correlations of acupuncture system / individual consciousness & collective consciousness, which may help in developing future strategies for integrative medicine & transpersonal psychology. In wider context, Tesla's whole research & life could also provide an inspiration for reconsideration of global educational / informational / political goals – with reorientation towards holistic gentle actions for solutions of the global risk society.

[Note 3. We also mention **radiesthesia**, as well-known method of transpersonal detection of geopathogenic & technical radiation [3,7] (**local**, probably via **EM induction** within EM-ionic-exotic circulatory acupuncture system, thereby modulating non-threshold acupuncture currents with extremely weak external EM fields too, as well as **nonlocal**, probably via **intentional quantum-gravitational tunneling of operator's individual consciousness** mentally addressed to part of collective consciousness of 'target' of radiesthetic detection in operator's transitional states of consciousness; in this context we also mention nonlocal radiesthetic detections of so called 'abstract radiations', like natural geometric 'forms' as well as human 'artifacts' & 'symbols' that might be related to them-mediating operator's interactions with corresponding 'archetypes' at level of collective consciousness).

There are also interesting possible mechanisms of **'radiesthetic protection'** of so-called **'radiation neutralizers'**, which appear to work – not by Faraday shielding of harmful EM fields but by **preventive harmonizing action on human acupuncture system** exposed to harmful EM fields (such as 'homeopathic preparations', or 'mentally encoded' neutralizers made of crystalline / non-crystalline materials, as indicated by pilot-research with bioelectrographic GDV camera of control & experimental groups exposed to EM field of mobile phones without & with radiation neutralizers).]

[Note 4. To readers interested in phenomenology of different altered states of consciousness, I also recommend book „**The Holographic Universe**“ [8], with numerous well-documented mysterious phenomena in altered states of consciousness.

*In this book, published in 1991 just before author's premature death, Michael Talbot is relying on research of two famous scientists, quantum physicist David Bohm & neurophysiologist Karl Pribram, who point out that **Universe might be giant hologram, sort of mind construct on subject / object boundary – relativizing question whether objective reality exists or fluctuates constantly between implicate & explicate orders!?***

*In this book, Michael Talbot (psychic himself!) points out that numerous **documented mysterious phenomena:***

***synchronicity & lucid dreams & eidetic images & multiple personalities, aura seeing and therapy & visualizing, hypnotic and miraculous healings, mystical religious experiences & out-of-body & near-death experiences, psychometry & precognition & extrasensory perception, psychokinesis & materialization & teleportation, might be explained within (still controversial) holographic paradigm.]***



## STATES OF CONSCIOUSNESS IN ESOTERIC PRACTICE

Petar Vujičin

*The future belongs to those who can  
think beyond the current paradigm*

**Abstract.** This paper argues that the study of the phenomenon of consciousness, and specifically of human states of consciousness, unlike the very recent preoccupation of the Western science with this problem, can be traced back to almost three millennia ago when it was investigated and personally explored by the sages of ancient India, who left behind written documents of their findings, which we know today as the Upanishads. The esoteric lines of other world's major religions have also pursued the investigation of consciousness in their own spiritual traditions as the most important subject-matter of all, arriving at virtually identical experiences and conclusions as the Upanishadic seers as to the nature of consciousness. The paper is focused on a comparative presentation of two esoteric practices which have been most articulate in the description of the results of their research: Upanishads, known under the collective term Vedanta (Hinduism) and esoteric Christianity as taught by a contemporary, venerable Cypriot mystic, simply called Daskalos (teacher). The striking correspondences between these two traditions have been found in all of their aspects, from the macrocosm, the structure of the Universe, to the microcosm, the structure of human selfhood, human bodies, human states of consciousness, and precise techniques for expansion and attainment of higher states of consciousness. Also, a brief comment is made on the psychic phenomena in the esoteric tradition, as well as on the research of these phenomena carried out by Western scientists. Finally, it is maintained that a conscientious implementation of esoteric disciplines and codes of behaviour in the many aspects of human life, personal and social, is the most efficient way for eliminating all evils (wars, crimes, poverty, illnesses, and diseases, unhappiness) that have beset humanity throughout its long history.

## **QUANTUM-HOLOGRAPHIC BASES OF PSYCHOSOMATICS & SPIRITUALITY: CONTRIBUTION TO COMPARATIVE EXPLORATION OF SCIENCE & RELIGION**

**Dejan Raković**

**Abstract.** We hereby focus on the quantum-holographic bases of psychosomatics and spirituality. This is of special importance due to the widespread use of integrative medicine in developed countries – as contemporary research of psychosomatic diseases suggests necessity of holistic methods (focusing on the body's acupuncture system and consciousness), oriented to treating man as a whole and not of disease as a symptom of disordered whole, implying their macroscopic quantum origin – with significant global psychosomatic implications of the necessity of including three front lines of integrative psychosomatic medicine. The aforementioned studies are in line with re-awakened interest in the scientific study of consciousness in recent decades (with indications of appearance of the grand synthesis of the two modes of knowledge, indirectly-rational and directly-mystical, in the framework of a quantum-holographic paradigm) – where the role of each individual becomes indispensable due to the influence and care for collective mental environment, which is fundamental question of mental hygiene and civic decency, or spiritual and civic morality. It should be noted that three essential aspects of any comparative study of science and religion are hereby included: utilitarianism and / or limitations of psychosomatic transpersonal practices of tribal traditions, meditation practices of the East, and prayer practices of the West, in healing or salvation of souls; epistemology of the two modes of knowledge, indirectly-rational and directly-mystical; and phenomenology of transpersonal-mystical, near-death, out-of-body, and extrasensory states of consciousness.

It should also be noted that **healing effects** on patient's acupuncture system / consciousness **are often blocked** by quantum-holographically encoded **spiritual personal consent** to disease as form of (self)punishment (as evidenced by subjects' experiences in **post-hypnotic regressions**), when **prayers & self-love for oneself & others** are necessary with aim of ending (self)punishment – thus performing **spiritual integration of personality**, i.e. **dis-entanglement of transpersonal energy blockages**, which initiates process of permanent healing [2-6].

Such **spiritual indeterministic interventions** by introducing new vacuum excitations of vital energy in otherwise deterministic quantum-holographic evolution of collective consciousness (similar to spiritually-excited & mentally-channeled Ayurvedic, Qigong, Reiki & modern experiences of local & transpersonal healings, thus **non-Schrodinger** imposing necessary **essentially new boundary conditions!**) – can permanently remove as net effect whole mutual conflict between two persons, which is also **greatest source of freedom** in optimizing life programs by spiritual cleansing [4-6].

In particular, let us mention **Hawaiian ho'oponopono tradition** with great reprogramming of life situations by contextual repentance & forgiveness to oneself; or **South American ayahuasca tradition** or **Nigerian abiku tradition** with incredible spiritual diagnoses & extensions of pre-destined short life programs; or fascinating **Anita Murdjani bestseller** on spiritual change in her life programs by returning from clinical death & after weeks of spontaneous healing from terminal phase of cancer; or contemporary **spiritual teaching of Bruno Grening** with incredible healing channel that remained open even after his death in optimization both individual & collective life programs; or traditional **Christian (hesychastic) Mysticism** with miraculous healing & optimizing life programs [2,4,6]!

This significantly contributes to our understanding that even **most severe psychosomatic disorders** have their roots in **energy-informational blockages**, and that healing begins by removing them – first by loving oneself, accepting oneself & forgiving oneself, which is then manifested by loving others & accepting others (e.g. **spiritually dis-entangling / unleashing repentant-forgiving prayer**)!

# **QUANTUM-INFORMATIONAL BIOMEDICINE & QUANTUM INFORMATICS: RELATIONSHIPS & PERSPECTIVES**

---

**QUANTUM ENTANGLEMENT, QUANTUM DECOHERENCE,  
QUANTUM TELEPORTATION, QUANTUM CRYPTOGRAPHY, QUANTUM COMPUTING**  
(PHYSICAL BASICS & APPLICATIONS IN COMPUTING & TELECOMMUNICATIONS;  
SHARPENING BASICS OF QUANTUM MECHANICS:  
UNIVERSALITY OF QUANTUM MECHANICS, BORDERS OF QUANTUM LIMIT,  
SPATIO-TEMPORAL QUANTUM ENTANGLEMENT,  
PHYSICAL NATURE OF QUANTUM COLLAPSE)

**QUANTUM-HOLOGRAPHIC NEURAL NETWORKS**  
(NON-LOCAL NATURE OF BODY'S ENERGY-INFORMATIONAL SYSTEM & PSYCHOSOMATICS;  
NON-LOCAL NATURE OF CONSCIOUSNESS & CREATIVITY AND SPIRITUALITY;  
TRANSPERSONAL INTERACTIONS & SPATIO-TEMPORAL QUANTUM ENTANGLEMENT IN  
BIOSYSTEMS WITH QUANTUM MEMORY:  
QUANTUM BIOLOGY, QUANTUM PSYCHOLOGY,  
HOLOGRAPHIC UNIVERSE)

**QUANTUM-INFORMATIONAL BIOMEDICINE**  
(DIAGNOSTIC & THERAPEUTIC METHODS OF QUANTUM-INFORMATIONAL MEDICINE;  
THREE FRONT LINES OF INTEGRATIVE PSYCHOSOMATIC MEDICINE:  
COLLECTIVE CONSCIOUSNESS, INDIVIDUAL CONSCIOUSNESS & BODY'S ENERGY-  
INFORMATIONAL SYSTEM, BODY)

# **SYMPOSIUM OF QUANTUM-INFORMATIONAL MEDICINE QIM 2011: ACUPUNCTURE-BASED & CONSCIOUSNESS-BASED HOLISTIC APPROACHES & TECHNIQUES**

**Belgrade, 23-25 September 2011**

## **Topics**

### **HOLISTIC MEDICINE & NON-CIRCULAR (PSYCHO/ ENERGY) THERAPIES FOR BALANCING ACUPUNCTURE SYSTEM & INDIVIDUAL CONSCIOUSNESS**

- Traditional Acu-Stimulations: Acupuncture/ Moxibustion/ Acupressure •
- Microwave Resonant Therapy • Bioresonant Diagnostics and Therapy •
  - Laseropuncture • Magnetotherapy • Segmental Reflex Massage •
- Lithotherapy • Chiropractic • Homeopathy • Chromotherapy • Aromatherapy •
- Aeroionization • Yoga Breathing • Meditation • Autogenic Training • Psychotherapies •

### **SPIRITUALITY & CIRCULAR (PSYCHO/ ENERGY) THERAPIES FROM ALL RELEVANT META-POSITIONS FOR BALANCING INDIVIDUAL & COLLECTIVE CONSCIOUSNESS**

- Prayers • Ho'oponopono • Transpersonal Psychotherapies • Family Constellations •
- Meridian Therapies • Qigong • Reiki • Reconnection • Theta • Shamanistic Traditions •

QUANTUM-INFORMATIONAL MEDICINE QIM 2011:  
ACUPUNCTURE-BASED & CONSCIOUSNESS-BASED  
HOLISTIC APPROACHES & TECHNIQUES

## QIM 2011 Symposium Proceedings

Editors

Dejan Raković  
Slavica Arandjelović  
Mirjana Mićović

QIM 2011  
Belgrade

QUANTUM-INFORMATIONAL MEDICINE QIM 2011  
ROUND TABLE KNOWLEDGE FEDERATION DIALOG BELGRADE 2011:  
PARTIAL VERSUS HOLISTIC ORIENTED APPROACHES

## QIM 2011 Round Table Knowledge Federation Proceedings

Editors

Dino Karabeg  
Dejan Raković  
Slavica Arandjelović  
Mirjana Mićović

QIM 2011  
Belgrade



## PROCEEDINGS

### 1st International Congress on Psychological Trauma: Prenatal, Perinatal & Postnatal Aspects (PTPPA 2015)

Editors

Grigori Brekhman  
Mirjana Sovilj  
Dejan Raković

Belgrade, Crowne Plaza  
15-16 May, 2015

# PRENATAL PSYCHOLOGY 100 YEARS



A JOURNEY IN DECODING HOW  
OUR PRENATAL EXPERIENCE  
SHAPES WHO WE BECOME!

EDITORS: JON RG TURNER, TROYA GN TURNER, OLGA GOUNI





# Beyond These Horizons

*Quantum Theory and Christian Faith*

John Breck

# THE MOUNTAIN *of* SILENCE

*A Search for Orthodox Spirituality*

"A fascinating narrative that is . . . dialogue and meditation,  
history and politics, theology and travelogue."—LOS ANGELES TIMES

KYRIACOS C. MARKIDES

# Healing

## the Spiritual Way

Through  
the Teachings  
of Bruno  
Gröning

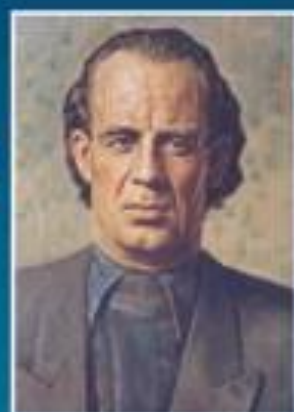

*A concise, systematic review of healings  
experienced world-wide in the communities  
of the Bruno Gröning Circle of Friends.*

**Matthias Kamp**

*Medical Director of the Medical-Scientific Group of Specialists  
of the Bruno Gröning Circle of Friends*

# FIRE IN THE HEART

## HEALERS, SAGES, AND MYSTICS

"Reveals how the innermost therapeutic practices  
are inseparably closely with Michael, Teresa, Rudolf,  
and Marie. A powerful statement on the subject of  
the Christian mystical tradition."

Leading Edge Review

**KYRIACOS C. MARKIDES**

Featuring the  
ancient Hawaiian  
teachings of Hooponopono

# zero limits

*The Secret  
Hawaiian System  
for Wealth, Health,  
Peace, and More*

**JOE VITALE**

Author of the bestselling *The Attractor Factor*

and **Ihaleakala Hew Len, PhD**

# CARLOS CASTANEDA

AUTHOR OF THE BESTSELLING *THE ART OF MEDITATION*  
**A SEPARATE REALITY**  
Further Conversations with don Juan



FORWARDED BY DR WAYNE W. DYER

# ANITA MOORJANI

"I had the choice to give up... or not. I chose to never give up.  
I realized that "Never" had a new meaning for me..."

## DYING TO BE ME

*My Journey from Cancer,  
to Near Death to True Healing*

Louise L. Hay *in* friends

# you can Heal your Life

Two Hours • Expanded Version  
includes bonus hours of audio material  
and one hour of interactive affirmations!

MUSIC BY  
JIM BRACKMAN  
DIRECTED BY  
MICHAEL  
GOODMAN



Copyrighted Material

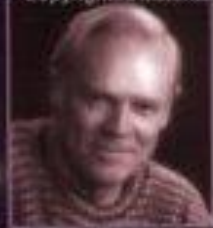

OVER 200,000  
COPIES SOLD!

MICHAEL NEWTON, PH.D.

# JOURNEY OF SOULS

CASE STUDIES OF  
LIFE BETWEEN LIVES

Copyrighted Material

# BEYOND PAST LIVES

What  
Past Lives  
Can Teach Us  
about Relationships,  
Healing, and  
Transmigration

# MIRA KELLEY

FOREWORD BY DR. WAYNE W. DYER

OVER 13 MILLION COPIES SOLD

# LIFE AFTER LIFE

THE 25<sup>TH</sup> ANNIVERSARY  
OF THE CLASSIC BESTSELLER

RAYMOND A. MOODY, JR., M.D.

NEW PREFACE BY MELVIN MORSE, M.D.  
FOREWORD BY ELISABETH KÜBLER-ROSS, M.D.

THE ELIADE GUIDE

## WORLD RELIGIONS

*The Authoritative Compendium of the  
11 Major Religious Traditions*

MIRCEA ELIADE  
& IOAN P. COULIANO

*with Hilary K. Flores*

First Complete  
Translation

THE  
TIBETAN  
BOOK  
OF THE  
DEAD

Introductory Commentary by  
HIS HOLINESS  
THE DALAI LAMA

PENGUIN CLASSICS  DELUXE EDITION

*The American  
book that has  
become Russia's  
most popular  
book on the  
afterlife,  
awakening  
countless  
souls with  
its sobering  
truth*



*The SOUL  
After DEATH*  
FR. SERAPHIM ROSE

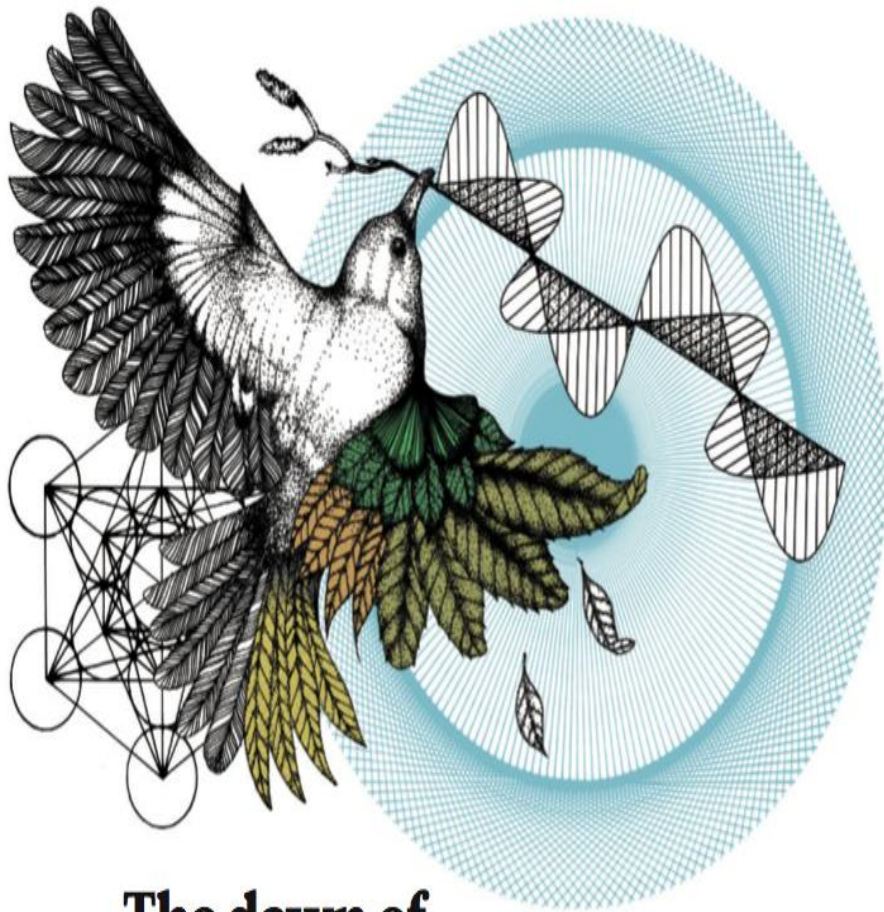

The dawn of  
**quantum  
biology**

*The key to practical quantum computing and high-efficiency solar cells may lie in the messy green world outside the physics lab.*

BY PHILIP BALL

Nature 474:272-274 (2011)

Quantum Brain Dynamics  
and Consciousness  
An introduction

Hari Jibu and Kuniyuki Yanai

Advances in Consciousness Research



John Benjamins Publishing Company



ИНСТИТУТ КВАНТОВОЙ ГЕНЕТИКИ

ПЕТР ГАРЯЕВ

ЛИНГВИСТИКО-  
ВОЛНОВОЙ  
ГЕНОМ

ТЕОРИЯ И ПРАКТИКА

Recent Advances in  
**Biophoton Research**  
and its Applications



# CONSCIOUSNESS AND THE SOURCE OF REALITY

*The PEAR Odyssey*

Robert G. Jahn and  
Brenda J. Dunne

# ENTANGLED MINDS

EXTRASENSORY EXPERIENCES  
IN A QUANTUM REALITY

DEAN RADIN

Bestselling author of *The Conscious Universe*

"From the frontier of consciousness research comes a work that could change how we see the nature of human consciousness and our engines and destiny."  
—Gary Zukav, M.D., author of *Seeking Soul*

FRONTIERS OF SCIENCE

ROBERT  
MILNER

# QUANTUM TECHNOLOGY

GERARD MILBURN

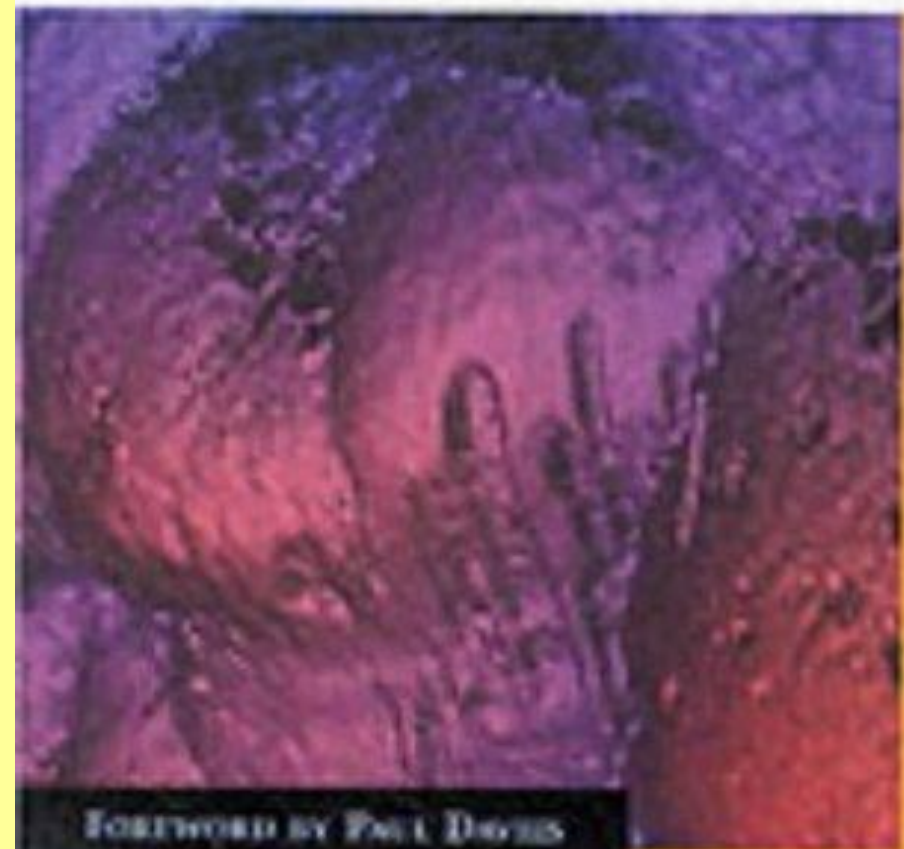

FOREWORD BY PAUL DAVIES

# Quantum Computation and Quantum Information

MICHAEL A. NIELSEN  
and ISAAC L. CHANG

CAMBRIDGE

## FINAL COMMENT

Our **QHQG theoretical framework of consciousness & psychosomatics**, in line with **increased scientific interest for consciousness** in past decades, anticipates **great synthesis** of two modes of knowledge, **rational-scientific** (classically-reduced, in normal states of consciousness) & **creative-religious** (quantum-entangled, in transitional & altered states of consciousness).

Thus **role of every individual** might become **irreplaceable** due to influence & care for **collective mental environment**, leaving most space for **free will**. This would point to **full significance of holistic education & behaviour** – demonstrating **necessity for redefining global educational / informational / political goals**, with reorientation towards **holistic gentle actions for solutions of global risk society**.

**Decisive role** in this process could be played by **all religious communities & transpersonal spiritual practices**, cultivating true **spiritual moral & absolute inter-personal, inter-ethnic & inter-religious tolerance**, as measure of individual behaviour from **perspective of death**, i.e. amount of generated & non-reprogrammed psychosomatic conflicts until death – which determine **spiritual evolution** of soul of deceased as well as **preferences** of individual and / or collective future of descendants, that can be **significantly altered** only via **collective prayer** for our neighbors & enemies & thus **global reprogramming of collective consciousness**.

## REFERENCES

1. D. Raković, S. Arandjelović, M. Mićović, eds., *Proc. Symp. Quantum-Informational Medicine QIM 2011: Acupuncture-Based & Consciousness-Based Holistic Approaches & Techniques*, QUANTTES & HF & DRF, Belgrade, 2011, [http://www.dejanrakovicfund.org/knjige/QIM\\_2011\\_Symposium\\_e-Proceedings\\_0.pdf](http://www.dejanrakovicfund.org/knjige/QIM_2011_Symposium_e-Proceedings_0.pdf), and refs. therein.
2. D. Raković, "Stress & anti-stress: Holistic quantum-informational framework with overview of recommended anti-stress approaches and techniques", and refs. therein (there is also its Serbian version, [http://www.dejanrakovicfund.org/2018\\_FDR\\_Stres\\_&\\_Antistres.pdf](http://www.dejanrakovicfund.org/2018_FDR_Stres_&_Antistres.pdf)), [http://www.dejanrakovicfund.org/2018\\_DRF\\_Stress\\_&\\_Anti\\_Stress.pdf](http://www.dejanrakovicfund.org/2018_DRF_Stress_&_Anti_Stress.pdf)
3. D. Raković, *Integrative Biophysics, Quantum Medicine, and Quantum-Holographic Informatics: Psychosomatic-Cognitive Implications*, IASC & IEPSP, Belgrade, 2009, and refs. therein (there is also its Serbian version, <http://www.dejanrakovicfund.org/knjige/2008-integ-biofiz-kvant-medic.pdf>), <http://www.dejanrakovicfund.org/knjige/2009-Integ-Biophys-Quant-Medic.pdf>
4. D. Raković, "On extended quantum-holographic framework for consciousness and free will: Round trip from science to spirituality", *International Journal of Prenatal & Life Sciences*, 3(3), 2019, p. 27, DOI:10.24946/IJPLS, <http://www.journalprenatalife.com/index.php/prenatal/article/view/58>; Presented previously at Int. W-S Congress Whole-Self Approaches in Psychology & Medicine, 13-14 Sept. 2019, Grootebroek, NL, Invited tutorial.
5. D. Raković, "On quantum-holographic and trans-generational implications for child development", in: J. R. G. Turner, T. G. N. Turner, O. Gouni, eds., *Prenatal Psychology 100 Years: A Journey in Decoding How Our Prenatal Experience Shapes Who We Become!*, A publication of The International Journal of Prenatal & Life Sciences, Cosmoanelixis, Prenatal & Life Sciences, Athens (2018), pp. 283-310, [http://www.dejanrakovicfund.org/radovi/2018\\_IJPLS.pdf](http://www.dejanrakovicfund.org/radovi/2018_IJPLS.pdf), Invited Chapter 7 (preprint), and refs. therein.
6. D. Raković, "Nikola Tesla as a case study for quantum-holographic correlations of individual and collective consciousness: Creative and spiritual implications", in: *Proc. Speech & Language 2019*, M. Subotić, S. Maksimović, eds., LAAC / IEPSP, Belgrade (2019), Invited lecture (preprint), and refs. therein, [http://www.dejanrakovicfund.org/prezentacije/presentations/2019\\_IEPSP.pdf](http://www.dejanrakovicfund.org/prezentacije/presentations/2019_IEPSP.pdf)
7. D. Janjić, *Radiations – Facts and Myths*, Belgrade, 2005 (in Serbian), with Preface by D. Raković to this interesting and useful book, <http://www.dejanrakovicfund.org/prezentacije/2005-JANJIC.pdf> (with English translation of the Preface, <http://www.dejanrakovicfund.org/prefaces/2007-JANJIC.pdf>), and refs. therein.
8. M. Talbot, *The Holographic Universe*, HarperCollins, New York, 1991; there is also Serbian translation, see also videolink of its Serbian promotion <http://www.dejanrakovicfund.org/video2.html>.

**BE WELL  
&  
THANK YOU  
FOR YOUR ATTENTION!**